

Article number: 391804903642310

Description: Worm gear with st. steel hollow shaft
VF 49 EP-F2-36- 63B14

Measures

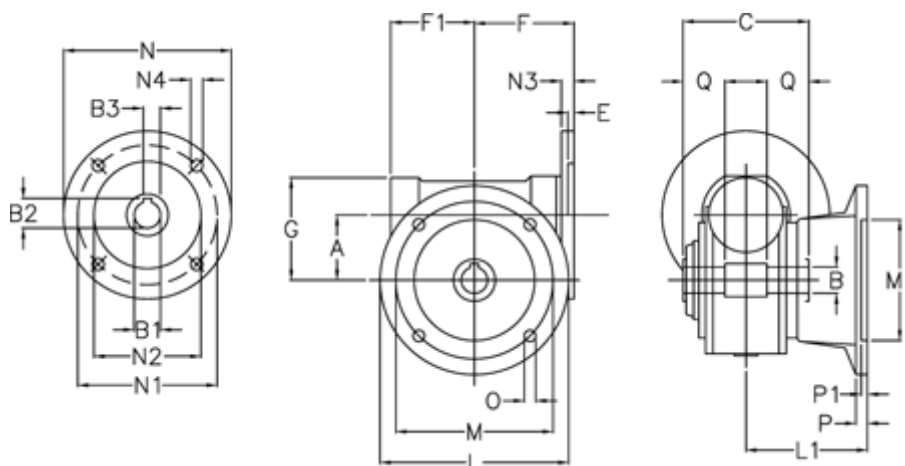

a	= 49.5	F1 = 63	N2 = 60
B	= 25	g = 80	N3 = 7.0
B1 E7	= 11	L = 125	N4 = 6.0
B2	= 12.8	L1 = 85.5	O = 10.5
B3 H9	= 4	m = 90	P = 12
C	= 82	M1 = 70	P1 = 10
E	= 3.0	N = 90	Q = 22.5
F	= 70	N1 = 75	